

KBU6005 THRU KBU610 SILICON BRIDGE RECTIFIERS

Reverse Voltage - 50 to 1000 Volts Forward Current - 6.0 Amperes

KBU

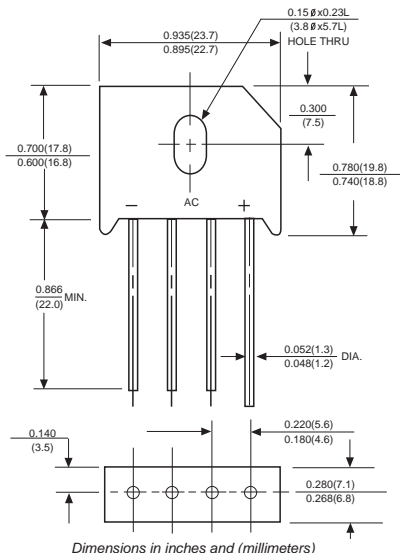

FEATURES

- ◆ The plastic package carries Underwriters Laboratory Flammability Classification 94V-0
- ◆ Ideal for printed circuit boards
- ◆ Low reverse leakage
- ◆ High forward surge current capability
- ◆ High temperature soldering guaranteed:
260°C/10 seconds, 0.375" (9.5mm) lead length, 5 lbs. (2.3kg) tension

MECHANICAL DATA

Case: Molded plastic body

Terminals: Plated leads solderable per MIL-STD-750, Method 2026

Polarity: Polarity symbols marked on case

Mounting: Thru hole for #6 serew, 5in.-lbs. torque max.

Weight: 0.27 ounce, 7.59 grams

MAXIMUM RATINGS AND ELECTRICAL CHARACTERISTICS

Ratings at 25°C ambient temperature unless otherwise specified.

Single phase half-wave 60Hz, resistive or inductive load, for capacitive load current derate by 20%.

Parameter	SYMBOLS	KBU 6005	KBU 601	KBU 602	KBU 604	KBU 606	KBU 608	KBU 610	UNITS
Maximum repetitive peak reverse voltage	V_{RRM}	50	100	200	400	600	800	1000	VOLTS
Maximum RMS voltage	V_{RMS}	35	70	140	280	420	560	700	VOLTS
Maximum DC blocking voltage	V_{DC}	50	100	200	400	600	800	1000	VOLTS
Maximum Auerage Forward(with heatsink Note 1) Rectified Current @ $T_c=100^\circ C$ (without heatsink)	$I_{(AV)}$	6.0							Amps
Peak forward surge current 8.3ms single half sine-wave superimposed on rated load (JEDEC Method)	I_{FSM}	175							Amps
Maximum instantaneous forward voltage drop per birdge element at 6.0A	V_F	1.0							Volts
Maximum DC reverse current at rated DC blocking voltage	I_R	$T_A=25^\circ C$							μA
		$T_A=100^\circ C$							mA
Typical Junction Capacitance (Note 1)	C_J	200							pF
Typical Thermal Resistance (Note 2)	$R_{\theta JA}$	4.7							$^\circ C/W$
Operating junction temperature range	T_J	-55 to +150							$^\circ C$
storage temperature range	T_{STG}	-55 to +150							$^\circ C$

NOTES:

1. Device mounted on 100mm*100mm*1.6mm Cu plate heatsink

RATINGS AND CHARACTERISTIC CURVES KBU6005 THRU KBU610

AVERAGE FORWARD RECTIFIED CURRENT,
AMPERES

FIG. 1- FORWARD CURRENT DERATING CURVE

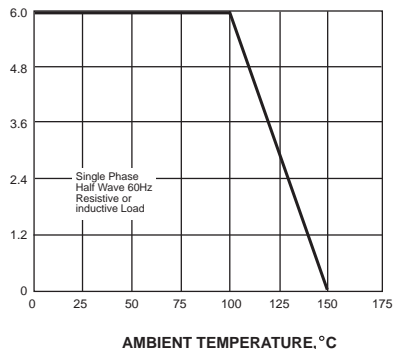

PEAK FORWARD SURGE CURRENT,
AMPERES

FIG. 2-MAXIMUM NON-REPETITIVE PEAK FORWARD SURGE CURRENT

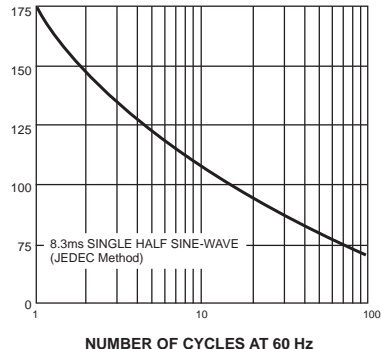

INSTANTANEOUS FORWARD CURRENT, AMPERES

FIG. 3-TYPICAL INSTANTANEOUS FORWARD CHARACTERISTICS

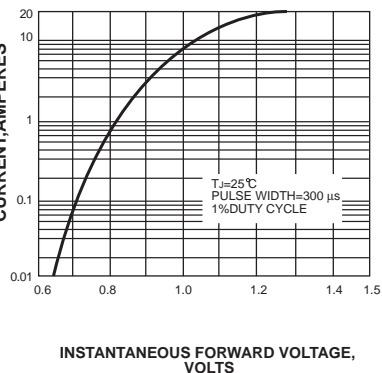

INSTANTANEOUS REVERSE CURRENT,
MICROAMPERES

FIG. 4-TYPICAL REVERSE CHARACTERISTICS

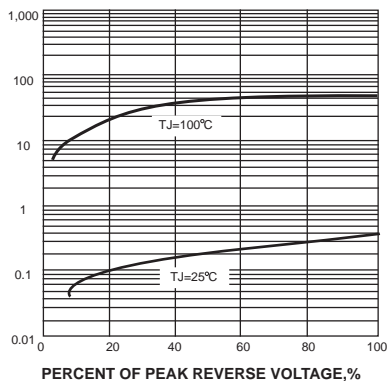

JUNCTION CAPACITANCE, pF

FIG. 5-TYPICAL JUNCTION CAPACITANCE

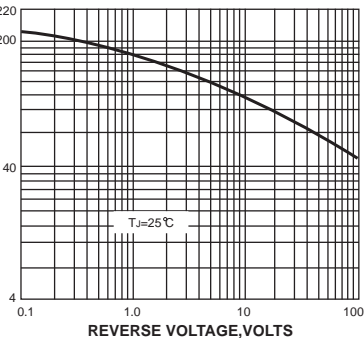

TRANSIENT THERMAL IMPEDANCE,
°C/W

FIG. 6-TYPICAL TRANSIENT THERMAL IMPEDANCE

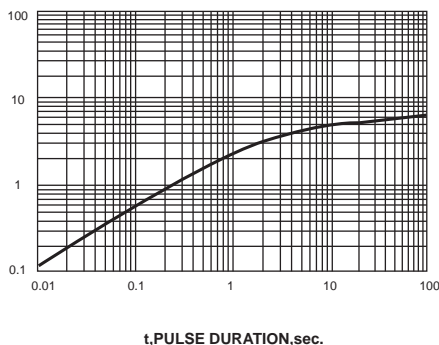

The curve graph is for reference only, can't be the basis for judgment